

# 给客户更多选择

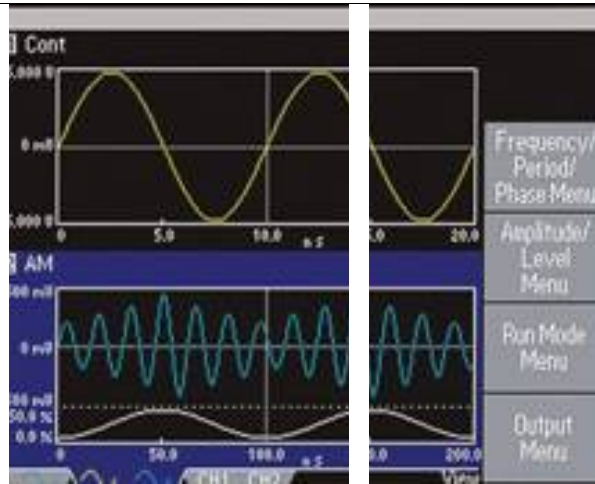

# 泰克设计工具系列不断扩大

- 重点满足嵌入式设计人员的需求
- 示波器是设计检验和调试使用的头号产品
- 台式仪器系列不断扩大
- 应用解决方案不断提高
  - 电源, 串行, 视频, 音频, 汽车
  - 探测和软件

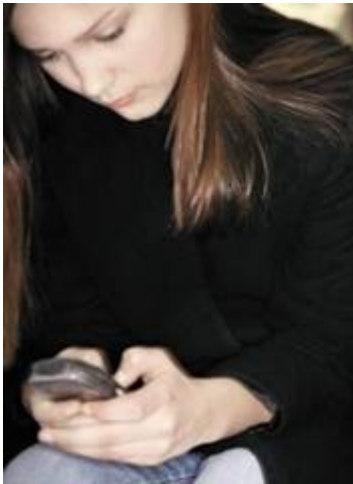

频谱  
分析仪



逻辑  
分析仪

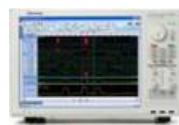

混合信号  
示波器



示波器



信号源



DMM



电源



# 应用重点

应用	市场	应用	市场
嵌入式设计		高级研发	
	消费电子 汽车 工业 医疗 航空 通信		行业 政府 教育
课堂教学		台式测试和维修	
	大学 技术学院 社区学院		维修中心 ODM/OEMs 分包制造















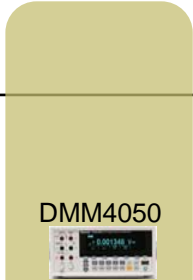



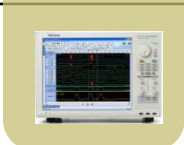



# 泰克PWS2000系列台式电源

泰克隆重推出基本台式电源家族

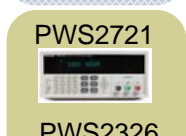
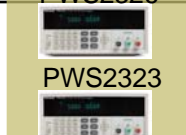
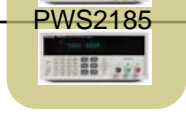

	PWS2185-SC	PWS2323-SC	PWS2721-SC	PWS2326-SC
最大功率	90 W	96 W	108 W	192 W
电压	0-18 V	0-32 V	0-72 V	0-32
电流	0-5 A	0-3 A	0-1.5 A	0-6 A

# 台式应用和产品契合图

	逻辑分析仪	示波器和MSOs	信号源	频谱分析仪	万用表	电源	
高级研发					 DMM4050  DMM4040  DMM4020	 将来	
嵌入式设计		   	  				 PWS2326  PWS2323  PWS2185
台式测试和维修		 	 				
课堂教学							

# PWS2000-SC概述

杰出的价值和功能

性能	通用性	易用性
		
<p>90-190 W功率 更宽的电压/电流范围 精确的10mV/10mA调整率</p>	<p>电压和电流回读 仪表模式回读 CC, CV, V Max控制模式</p>	<p>明亮的大的回读读数 直接键入设置 16个用户设置存储 用户自定义开/关模式</p>

# 多功能台式电源

- 串联或并联操作, 提供了更大的灵活性和更高的输出
- 根据不同接地定义提供正或负隔离输出
- 可堆叠功能
  - 多台电源或DMM可以堆叠起来
- 带口令保护的前面板锁定装置
- 外观紧凑 (半个19英寸机架宽度)

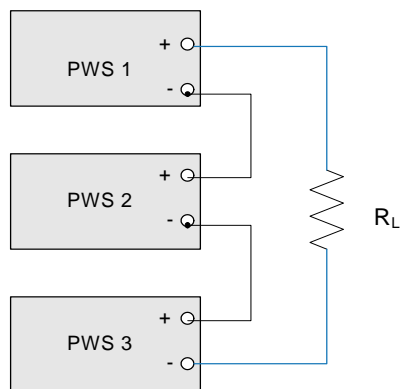

串联设置

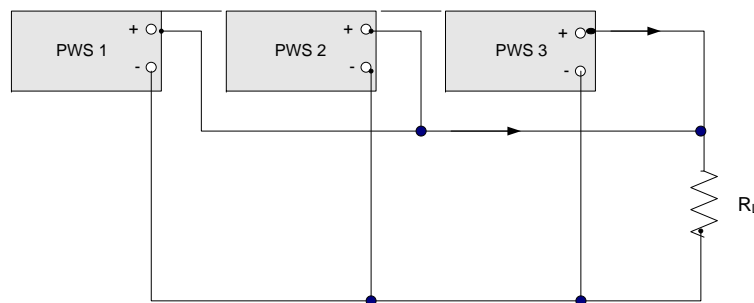

并联设置

# PWS2000-SC系列小结

杰出的性能和价值, 适用于  
嵌入式设计  
生产测试  
教育



	PWS2185-SC	PWS2323-SC	PWS2721-SC	PWS2326-SC
最大功率	90 W	96 W	108 W	192 W
电压	0-18 V	0-32 V	0-72 V	0-32
电流	0-5 A	0-3 A	0-1.5 A	0-6 A
控制模式	恒定电压 (CV), 恒定电流 (CC), 最大电压			
用户设置	16个自定义设置			
保修	三年			



## 小结

- PWS2000-SC系列电源有效完善了泰克台式测试解决方案
- 台式测试解决方案系列不断扩大

